

# 规格承认书

## SPECIFICATION FOR APPROVAL

签核栏 **SIGN NETHERLANDS**

供应商/VENDOR			客户/CUSTOMER		
批准 Approve	审核 Check	拟制 Preparation	批准 Approve	审核 Check	拟制 Preparation
日期 DATE:09/12/2019					

请签字确认并回传本司 PLEASE SIGN AND RETURN ONE COPY.

签字后，您同意本承认书内容，所有产品将按此要求生产。

With your signature, you agree that all contents in this approval sheet are correct and all production units will be built according to the specification described in this sheet.

备注 REMARKS: \_\_\_\_\_

客户名称  
CUSTOMER \_\_\_\_\_

客户料号  
PART NUMBER \_\_\_\_\_

产品类别 **AC DC ADAPTER**  
PRODUCT \_\_\_\_\_

设计编号 **ZH-6039** 机种型号 **KS39DU-1200200CK**  
DESIGNED NO. \_\_\_\_\_ MODEL NO. \_\_\_\_\_

版本号 **012**  
VERSION NUMBER \_\_\_\_\_

**深圳市振欢电子有限公司**

**Shenzhenshi Zhenhuan Electronic Co., Ltd.**

电话(Tel):(+86)0755-81461285 传真(Fax):(+86)0755-81461215

地址 ADD:广东省深圳市宝安区福永凤凰第一工业区凤兴巷1号景业坊  
工业园2栋8-9层

8-9th FL, BL 2, Jingyefang, No.1 Fengxing Lane, Fenghuang First Industrial  
area, Fuyong, Bao'an District, Shenzhen, China

### 修改记录（Specification Change History）

项目 Item	修改日期 Revision	修改内容 Revision Content	生效日期 Effective date	确认 Arbiter	修改人 Revisor

产品型号： MODELNO.:	KS39DU-1200200CK
设计编号： DESIGNED NO.:	ZH-6039
日期： Date	2019

批准 Approve	审核 Check	拟制 Preparation

# 索引 (Index)

1.概述 (Scope) .....	4
2.电器规格 (Electrical Specifications) .....	4
3.保护功能 (Protection) .....	6
4.可靠性 (Reliability) .....	7
5.环境特性 (Environment) .....	9
6.安全及 EMI 要求 (Safety and EMI Requirement) .....	10
7.测试设备清单 (The Equipment List) .....	11
8.结构参数 (Mechanical requirement) .....	11
9.机械规格 (Mechanical Specifications) .....	12
10.电路示意图 (Circuit Schematic Drawing) .....	13
11.印刷电路板图 (PCB Diagram) .....	14
12.铭牌图 (Label Drawing) .....	14
13.包装图 (Package Drawing) .....	15

## 1.概述 (Scope)

The document detail the electrical, mechanical and environmental specifications of a SMPS, the power supply provide 24W continuous output power.

资料详细描述了一款24W(连续输出功率)开关电源的电气性,结构性及环境等要求。

The power supply shall meet the RoHS requirement.

电源符合RoHS 要求。

### Description/类型

- SMPS Adaptor(Wall mount)/插墙式适配器       SMPS Adaptor(Desk-top)/桌面型适配器
- Open Frame/开放式结构       SMPS Unit (With Case)/带铝壳型
- Others/其他

## 2.电气规格 (Electrical Specification)

### 2.1 输入 (INPUT)

输入电压范围(Input voltage range)	90Vac-264Vac
额定输入电压范围 (Rated voltage range)	100Vac-240Vac
适用频率范围 (Input frequency range)	47Hz-63Hz
额定频率 (Rated input frequency)	50Hz/60Hz
输入电流 (Input AC current)	$\leq 0.6A_{rms}$ at 100 to 240Vac input
浪涌电流【Inrush current (cold start)】	lower than 50/80 A under cold start and 1st half cycle of 115/230 Vrms
输入保险 (Input Fuse)	The input fuse shall not blow up.
待机功耗 (No load power dissipation)	$\leq 0.15W$ max. @230Vac/115Vac input & No Load.
泄漏电流 (AC Leakage Current)	0.05mA Max @230Vac input.

### 2.2 输出 (OUTPUT)

#### TEST MEASURES

C1: 0.1uF CERAMICS CAPACITOR    C2: 10uF 50V ALUMINUM CAPACITOR

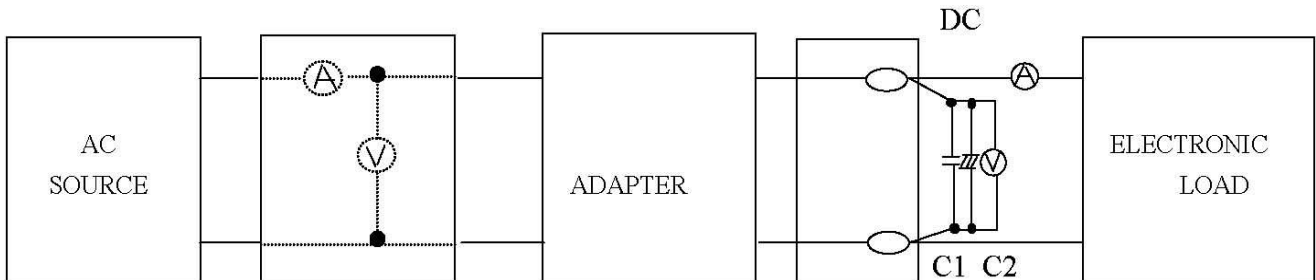

### 2.2.1 额定输出 (Rated Output)

输出电压 output voltage (Vdc)	输出电压范围 output voltage Limit (Vdc)	纹波&噪声 Output Ripple & Noise (mV)	最大输出电流 Output Current (mA)
12V	11.4-12.6	≤120	2000mA

注 (Notes)：在测试纹波时示波器带宽调至20MHz，示波器的测试端并入一粒10uF的电解电容和一粒0.1uF的瓷片电容) 方框图如下：(Ripple Voltage is measured with oscilloscope with bandwidth 20MHz . A 10uF ceramic-cap shall be connected to the connector in parallel.) Block diagram as following:

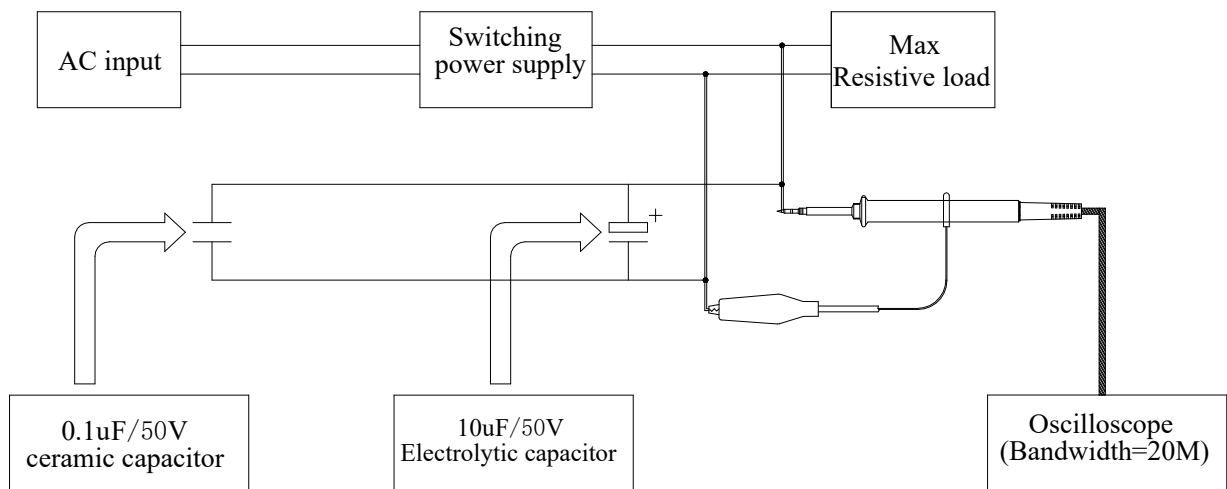

### 2.2.2 输出超调 (DC Output Overshoot At Turn On & Turn off )

输出电压 output voltage (V)	输出超调电压比例 Proportion of the output voltage overshoot	
	开通 Turn on	关断 Turn off
12V	5%	5%

注 (Notes)：在全部电流范围内进行测试 (All of dc output current for Min. to Max.)

### 2.2.3 负载特性, 调频率 (Combined Load/Line Regulation)

电压 voltage	最小负载 Min. load	额定负载 Rated.Load	线性调整 Line Regulation	负载调整 Load Regulation
12Vdc	0A	2A	±2%	±5%

#### 2.2.4 启动延迟时间 (Turn on delay time)

当输入 100Vac to 240Vac 和输出最大负载时, 最大启动时间为 3S.

3s max@ 100Vac to 240Vac input and output Max.Load

#### 2.2.5 上升时间 (Rise time)

当输入 100Vac to 240Vac 和输出最大负载时, 最大时间为 30mS.

30ms max@100Vac to 240Vac input and output Max.Load

#### 2.2.6 保持时间 (Hold up time)

当输入 115Vac/230Vac 和输出最大负载时, 最小保持时间为 10mS/20mS.

10mS/20mS Min. at 115Vac/230Vac input and output Max. Load.

#### 2.2.7 效率 (Efficiency)

在 230Vac/50Hz 及 115Vac/60Hz 输入时, 输出在 25%, 50%, 75%及满载情况下, 平均效率  $\geq 84\%$  (煲机 30 分钟后测试), 及空载输入功率  $\leq 0.15W$ .

In 230 Vac / 115 Hz and 230Vac / 60 Hz input , The output at 25%, 50%, 75% and full load cases , The average efficiency of  $\geq 84\%$  (testing after 30 minutes), And no-load input power  $\leq 0.15W$ .

### 3. 保护功能

#### 3.1 短路电路保护 (Short circuit protection) :

在 DC 端短路的情况下该电源将不会损坏.

该电源供给器在短路解除时能正常工作恢复.

The power supply shall not be damaged by short between DC output and DC ground.

The power supply shall automatically restart when short to ground are removed.

#### 3.2 过流保护 (Over current Protection)

当过电流时, 电源处于保护状态, 当过电流情况解除后, 产品将会自动恢复正常.

The power supply shall be in protection status when the over currents applied to the output rail, and shall be self-recovery when the fault condition is removed.

AC input voltage	Over Current Protection	Short Circuit Protection
100-240Vac	2.6A-3.8A	Hiccup

#### 3.3 过压保护 (Over Voltage Protection)

When the output over-voltage, the power supply into the hiccup protection status, and shall be self-recovery when the fault condition is removed.

当输出过压时, 电源进入打嗝保护状态, 当过压状况解除后, 则会自动恢复正常。

## 4.可靠性要求(Reliability Requirements)

### 4.1 老化 (Burn-in)

产品要在 40℃±5℃的环境及 80%额定负载条件下煲机 2-4 小时

Products need to be burned-in 2-4 hours , In 40 °C ±5 °C and the 80% of the load.

### 4.2 平均间隔故障时间估算 (MTBF Qualification)

\*Standard: MIL-HDBK-217F

平均间隔故障时间: 至少 50,000 小时, 25℃环境及额定输入与满载条件下

The MTBF shall be at least 50,000hours at 25°C , Full load and nominal input condition

Output Voltage	Min Voltage	Max Voltage	Current	MTBF	Load Condition
+12VDC	+11.4Vdc (-5%)	+12.6Vdc (+5%)	2.0A	50000Hr	100%

### 4.3 高压测试 (Hi-Pot test)

#### 1)Hi-Pot tests (Dielectric withstand voltage)-CLASS II

: leakage(cutoff) current 10mA

: Safety Test:

Primary To Secondary : 3000Vac ,1 minute for type test

Production Line:

Primary To Secondary : 3000Vac ,keeping 2 seconds for production

\* Test methods:Input test voltage begining from zero to 3600Vac in 0.5s.We move plug after discharge display 0V.

\* Test point : Primary Live and Natural Short ↔ Secondary

#### 2).Hi-Pot tests (Dielectric withstand voltage)-CLASS I

: leakage(cutoff) current 10mA

: Safety Test:

Primary To GND : 1500Vac ,1 minute for type test

Primary To Secondary : 1500Vac ,1 minute for type test

Production Line:

Primary To GND : 1800Vac ,keeping 2 seconds for production

Primary To Secondary : 1800Vac ,keeping 2 seconds for production

\* Test methods:Input test voltage begining from zero to 1800Vac in 1s.We move plug after discharge display 0V.

\* Test point : Primary Live and Natural Short ↔ Ground

4.4 雷电浪涌测试 (Lighting Surge)

The Power Supply must satisfy Table's Lighting Surge Spec.

1) Test Condition

Note:

a. Environment Requirements: temperature :15~35°C; humidity :10%~75%RH

b.Surge voltage is applied to the phase: 0° 90° 180° 270°

c.Surge voltage is applied: for each polarity voltage of each repeated 5 times, a phase done 10 times,each applied voltage interval of 60 seconds

4.4 绝缘阻抗 (Insulation Resistance)

Insulation resistance shall be more than 10MΩ at 500Vdc between Primary Live, Primary Neutral and secondary 在初级与次级间加500Vdc 进行测试，最小50MΩ。

Products	Test Voltage	Test Point & Test Mode	Number of Test times
Adapter N/A	±1KV	Line to Line : C-Mode	± Each Voltage 3-times
	N/A Line to Gnd : CR-Mode	Line to Gnd : CR-Mode	



## 5.环境要求 (Environmental Requirement)

### 5.1 工作温度 (Operating Temperature) :

0°C-40°C, 满载, 正常工作

0°C to 40°C, Full load, Normal operation.

### 5.2 储藏温度 (Storage Temperature)

- 40°C to 85°C 【带外壳 (with package)】

### 5.3 工作湿度 (Relative Humidity) :

5% (0°C) ~95% (40°C), 72 小时, 满载, 正常工作.

5% (0°C) ~95% (40°C) RH, Full load, Normal operating.

### 5.4 振动 (Vibration)

#### 5.4.1 测试标准: 国际电工电子委员会

Operating: IEC 721-3-3 3M3

5~9Hz, A=3.5mm

9~200Hz, 加速度 Acceleration 5m/S

#### 5.4.2 运输 (Transportation) :

IEC 721-3-3 2M2

5~9Hz, A=3.5mm

9~200Hz, 加速度 Acceleration= 5m/S

200~500Hz, 加速度 Acceleration= 15m/S

#### 5.4.3 轴向振动 (Axes, 10 cycles per axis) :

在测试过程中不能出现永久性的损坏.

No permanent damage may occur during testing.

在电源开启和关闭后, 样机能够恢复到最初条件.

The product can restore to its original situation after power off / on.

### 5.5 跌落试验(Dropping Packed)

一个角, 三个棱, 六个面。

1 corner, 3 edges, and 6 surfaces.

高度 76cm

Height: 76cm

### 5.6 工作高度 (Operation Altitude)

→0-5000m

## 6.安全及 EMI 要求（Safety and EMI Requirement）：

### 6.1 安全：符合标准（Safety: accord with）

Certificate	国家/Country	Standards	
<input checked="" type="checkbox"/> UL/CUL	美国/USA	UL1310	
<input checked="" type="checkbox"/> UL/CUL	美国/USA	UL62368 60950	
<input type="checkbox"/> TUV/GS	欧洲/Europe	EN60065	
<input checked="" type="checkbox"/> TUV/GS	欧洲/Europe	EN62368 60950	
<input checked="" type="checkbox"/> FCC	美国/USA	Class B	
<input type="checkbox"/> CE	欧洲/Europe	EN60065	
<input checked="" type="checkbox"/> CE	欧洲/Europe	EN62368 60950	
<input type="checkbox"/> MEPS	澳洲/Australia	As/NZS 4665	
<input type="checkbox"/> SAA	澳洲/Australia	As/NZS 60065	
<input checked="" type="checkbox"/> SAA	澳洲/Australia	As/NZS62368 60950	
<input type="checkbox"/> CCC	中国/China	GB8898	
<input checked="" type="checkbox"/> CCC	中国/China	GB4943	
<input checked="" type="checkbox"/> PSE	日本/Japan	J62368 60950 (H22)	
<input type="checkbox"/> CB	欧洲/Europe	IEC60065	
<input checked="" type="checkbox"/> CB	欧洲/Europe	IEC62368 60950	
<input checked="" type="checkbox"/> C-TICK	澳洲/Australia	As/NZS CISPR13: 2004	
<input checked="" type="checkbox"/> EK/KC	韩国/Korea	K60950	

### 6.2 EMI 标准（EMI STANDARD）：

EN55032	EN55015
GB17625	GISPR 22
GB9254	FCC Part15

### 6.3 EMS Standards/EMS 标准

EN 61000-3-3	Voltage fluctuations & flicker;
EN 61000-4-2	Electrostatic Discharge(ESD): 8kV air discharge, 4kV contact discharge;
EN 61000-4-3	Radio-Frequency Electromagnetic Field Susceptibility Test-RS;
EN 61000-4-4	Electrical Fast Transient/Burst-FET;
EN 61000-4-5	Surge Immunity Test: AC Power Line: line to line 1kV, line to earth 2kV;
EN 61000-4-6	Conducted Radio Frequency Disturbances Test-CS;
EN 61000-4-8	Power Frequency Magnetic Field Test;
EN 1000-4-11	Voltage Dips;

### 6.3 绝缘强度 (Dielectric Strength Testing) :

绝缘强度满足下表的要求, 100% 在线超频执行此项测试, 并每一项目至少保持 5S 时间, 无任何故障。

Hi-pot test shall be met the table 5 requirements, an item listing this test as a 100% production test must be performed and be maintained at that level for a minimum of 5 seconds without failure.

## 7. 测试设备清单 (Test Equipment List)

项目	设备名称	制造	型号
1	变频电源 (AC power source)	Chroma	6120
2	示波器 (Oscilloscope)	Tektronix	TDS1002B
3	电子负载仪 (Electronic load)	TET	T3515
4	万用表 (Multimeter)	FLUCK	87 III
5	功率计 (Dynamometer)	Chroma	2100
6	温度表 (Thermograph)	LUTRON	TW-902C
7	插头引线弯折试验机 (Plug lead bend test machine)	联欣	LX-817
8	盐雾试验机 (Salt spraying tester)	联欣	LX-8827B
9	震动台 (Vibration table)	精技试验	FZD-25
10	跌落试验台 (Drop test bed)	自制	
11	数显卡尺 (Digimatic caliper)	上海量具	0-150mm

## 8. 结构参数 (MECHANICAL REQUIREMENT)

### 8.1 外壳 (Enclosure) ;

外壳尺寸: 77mm\*47mm\*31mm;

### 8.2 输入 (Input)

2 Pin 插脚

Two pin

## 9.机械规格（MECHANICAL SPECIFICATIONS）

### 9.1 物理尺寸（Dimension）：

77mm\*47mm\*31mm （ L \* W \* H ， 见图 ）

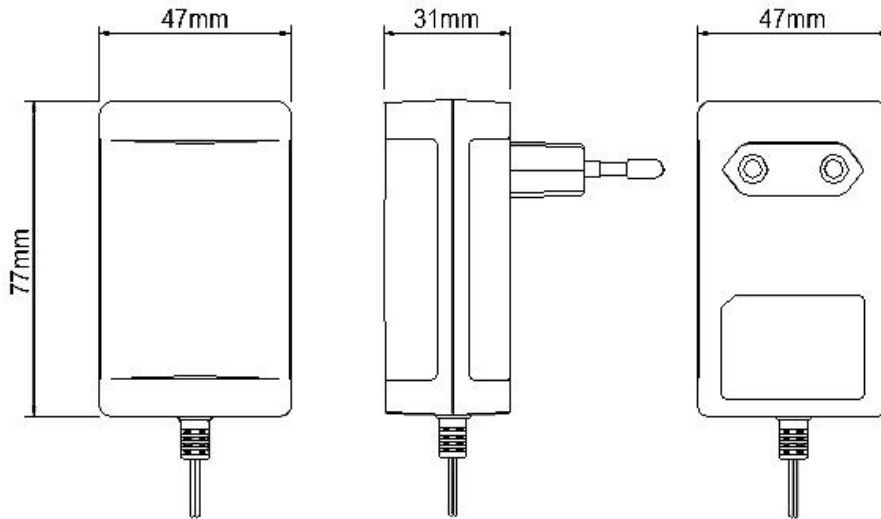

### 9.2 DC 线尺寸图（DC output cord Drawing）：

（见图）。UL 2468/1.2M DC 头：5.5\*2.1mm

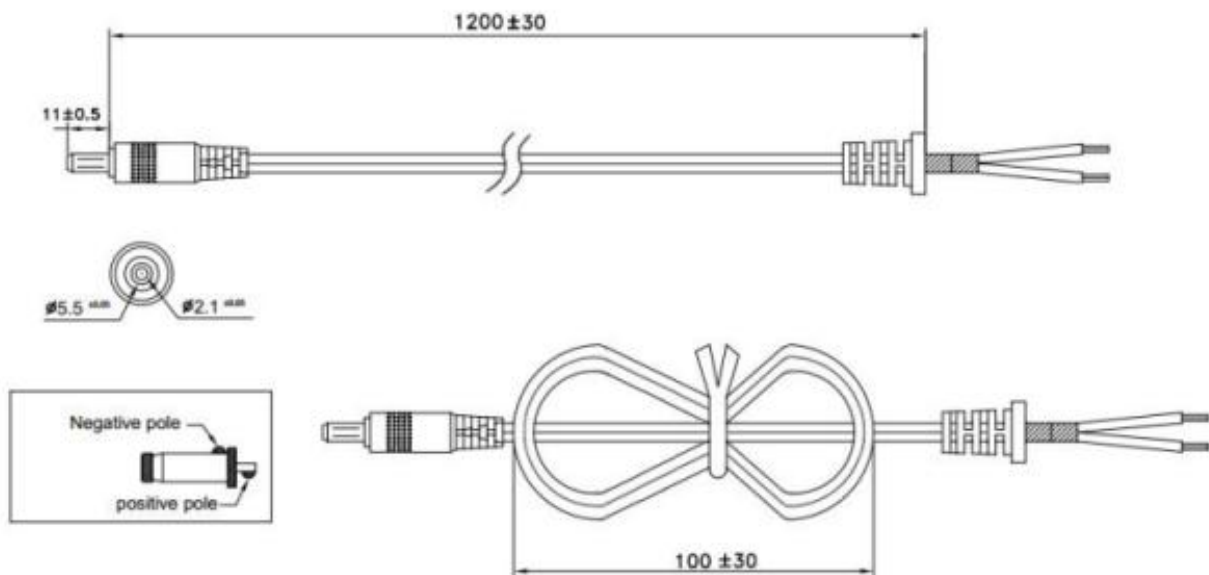

### 9.3 极性 (Polarity)

#### 9.3.1. 极性 (Polarity) :

内正外负/Center Positive

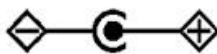

## 10. 电路示意图 (Circuit Schematic Drawing)

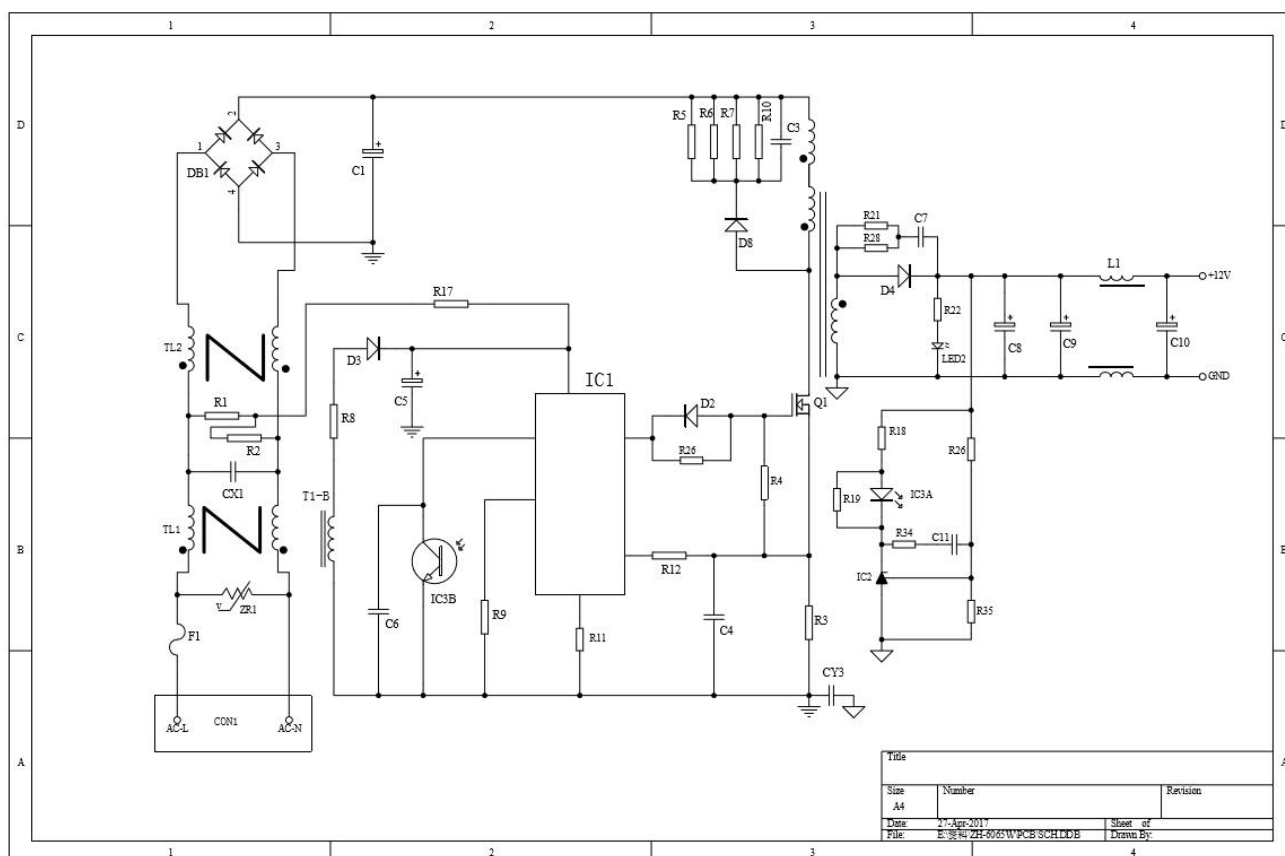

## 11.印刷电路板图 (PCB Diagram)

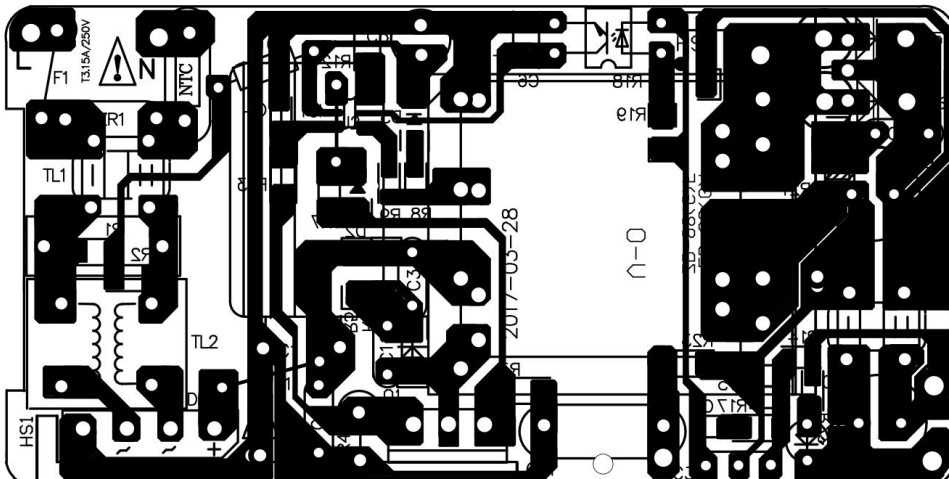

## 12.铭牌图 (Label Drawing)

12.1 标签内容/可镭雕 (见图)

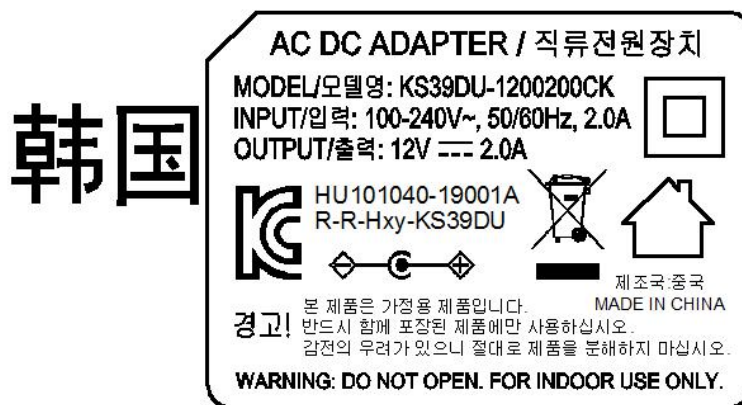

12.2 周期码 (Cycle code)

S/N: XX XX XX XXXXXX

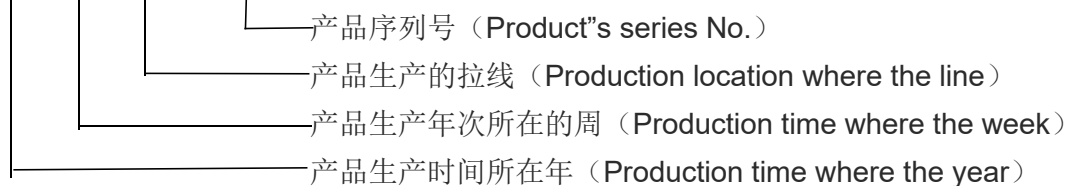

例如上铭牌所示的 193601000001

For example “193601000001” show on label.

19 代表 2019 年, 36 代表 2019 年中第 36 周, 01 代表产品生产的拉线, 000001 代表产品序列号。

19 means 2019, 36 means the 36<sup>st</sup> week, 01 means production location line 1, 000001 means product series No. is 1.

### 13. 包装图 (Package Drawing)

a. 外箱/outer package: 36\*35.2\*25CM

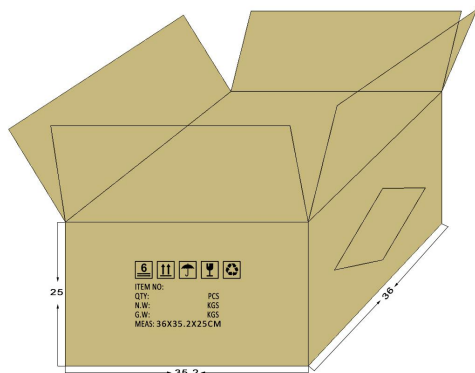

c. 内盒/inner box: 115\*68\*55MM

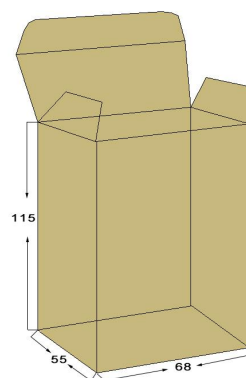

b. 侧面/Left side

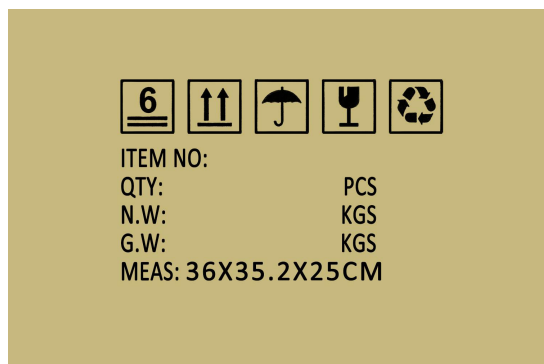

d. 包装/package 60PCS/CARTON

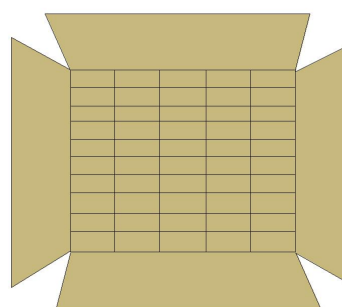

#### 包装说明 (PACKING)

若客户未提出包装方式时，均使用本公司的包装方式。

**Our own packing style will adopted if no special packing required.**

**1. 内包装/inner package**

小黄盒/inner small box

**b 外包装/Outer package**

纸箱/paper-box

尺寸: 360\*352\*250mm,

**C 外包装箱标识 / Outer package notes include the information**

客户、订单号、品名、数量、日期等信息

**Customer Name, LOT Number, MODEL No, Date, and so on**